

DRK

ALUMINUM KNURLED INDICATOR KNOBS

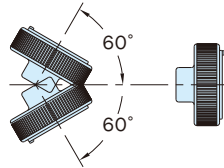
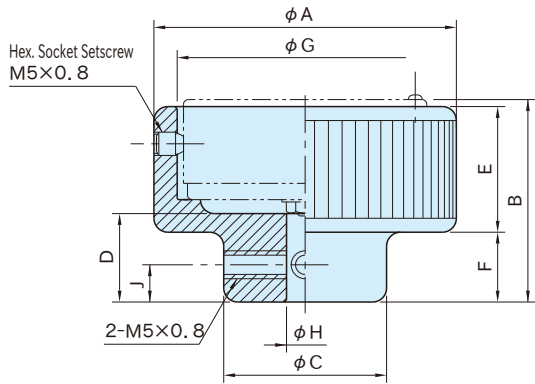

Angular Range of Mounting

Note : Dial Indicator must be ordered separately.

Knob
Aluminum alloy (ADC12)
Baked finish
Silver gray

Part Number	A	B	C	D	E	F	G	H (H8)	J	Weight (g)
DRK65	65	43.5	35	19	27	15	55	8	8	120
DRK90	90	51	38	24	28	20	75.7	10		250

Proper Dial Indicators

Handwheels	Dial Indicators	
	D50R/L/C	D75R/L/C
DRK65	○	×
DRK90	×	○

· Center Caps are available for applications without a indicator

Technical Information

For detailed installation instructions, see page of "IMAO INDICATOR HANDWHEELS & INDICATOR KNOBS".