

# DK01F,208,209

# CONTROL KNOBS



DK01F



DK01F-ST

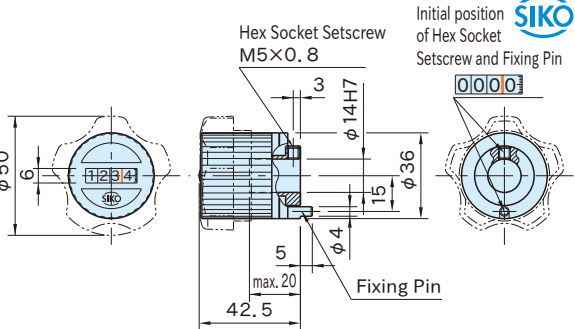

DK01F



DK208

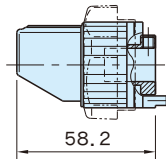
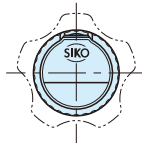

DK208 DK209



DK209

Housing	Knob
Special polycarbonate	Plastic
plastic	Red
Black	Black (on request)

## Features:

- Control knob with integrated digital position indicator
- Lightweight and compact
- Using a shaft sleeve allows accepting a shaft of 8mm, 10mm or 12mm diameter.
- Magnified display

## Caution :

Can not be used on machines where the spindle moves in the axial direction.  
To operate, turn the knob to the rotative direction

## Application Example

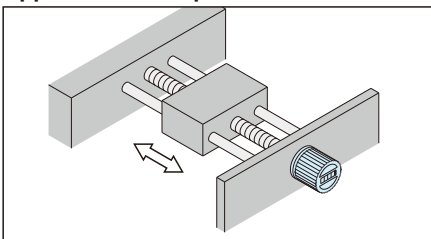

## Installation Instructions

- Drill a fixing-pin hole into the mounting wall at a position 15mm below the spindle-hole center.
- Slide the control knob over the spindle and then tighten the setscrew for locking.

## Technical Information

Working temperature : Up to .80°C

## Display Example

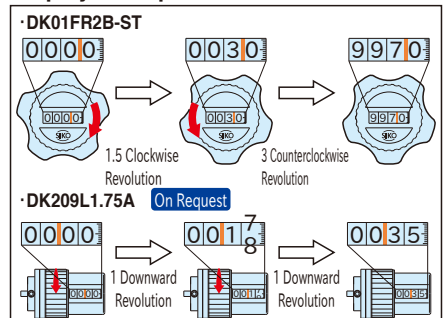

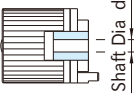
Type	Spindle Thread Pitch	Value Displayed After 1st Revolution				Weight (g)	Shaft Sleeve
		A On Request	B	C On Request	D On Request		
DK	1.25	00123	00123	00123	-	60	
	1.5	0015	0015	0015			
	1.75	00178	00178	00178			
	2	0020	0020	0020			
	2.5	0025	0025	0025			
	3	0030	0030	0030			
	4	0040	0040	0040			
	5	0050	0050	0050			
10	-	01100	01100	01100			

**Ordering Example**

**DK 01F R 2 B -ST**

Style      Rotative Direction      Spindle Thread Pitch      Value Displayed After 1st Revolution      Star Knob

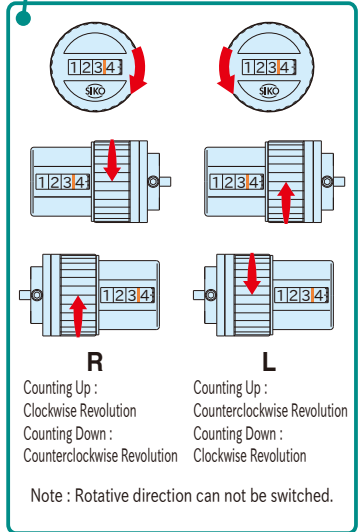

Notes:  
 • Black color is available only for **DK01F** version.  
 • Star knobs are assembled at ourfactory.